

3 BODY SHEARBOLT FIXED / FOLDING BED MAKER

ABOUT

The ScanStone bed maker range adopts the classic ScanStone style body and ploughs, leaving a wide bottom trench for the stones and clods to lie in as it pulls through the ground.

The 3 body bed maker comes with both a folding frame or a fixed frame and is compatible with the ScanStone 3.6m bed tiller.

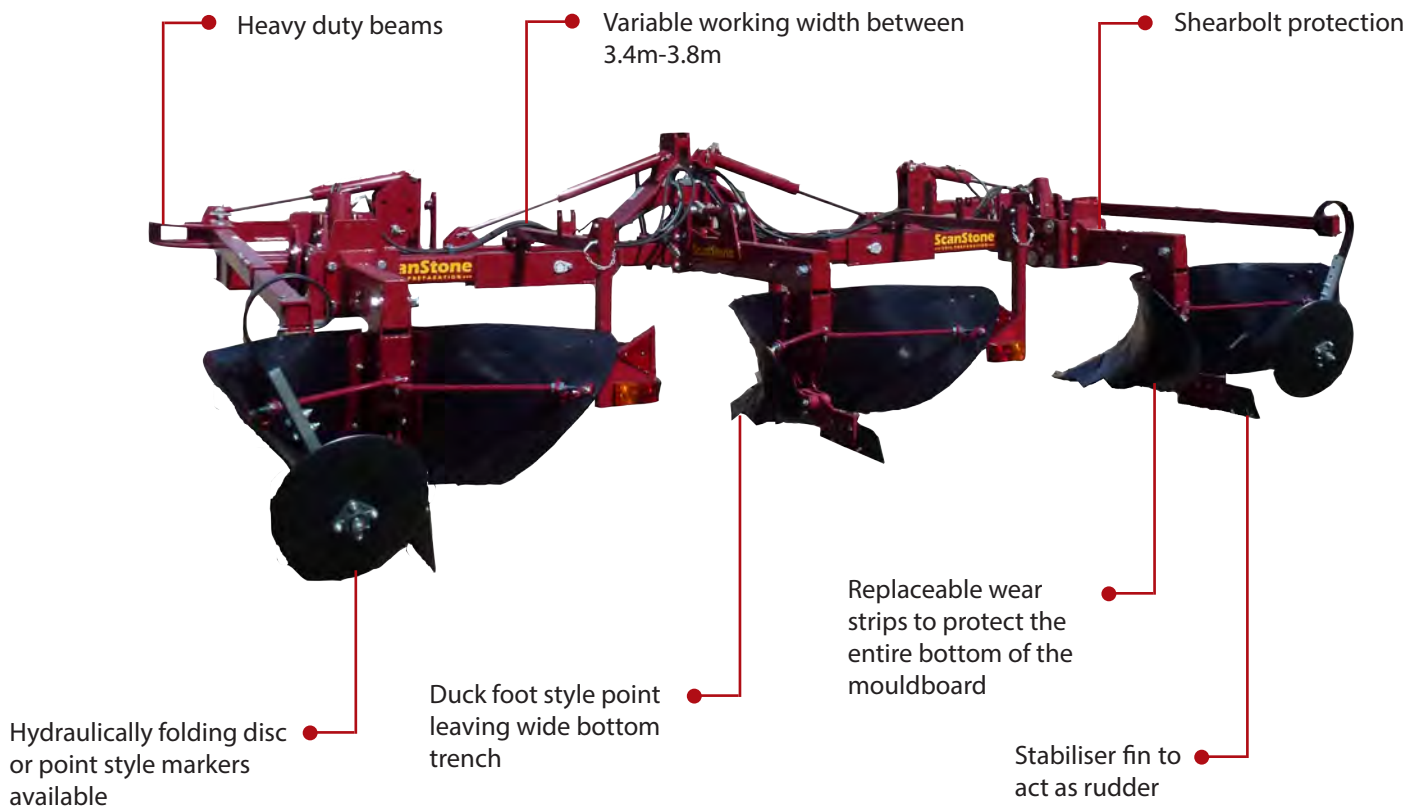

This bed maker is available in **TERRA SPEC**
See page 19 for details

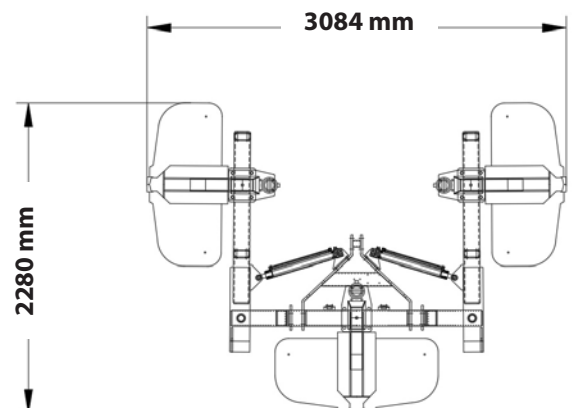
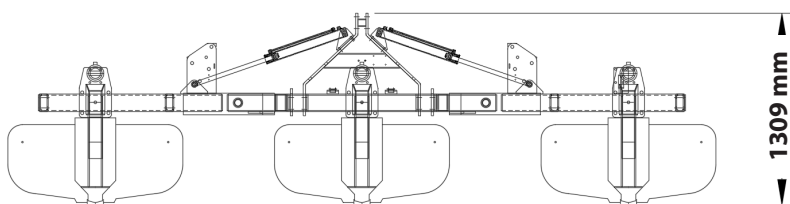

3 BODY AUTO RESET FIXED BED MAKER

ABOUT

The ScanStone bed maker range adopts the classic Reekie style body and ploughs, leaving a wide bottom trench for the stones and clods to lie in as it pulls through the ground.

The 3 body bed maker comes in both a folding frame or a fixed frame and is compatible with the ScanStone 3.6m bed tiller.

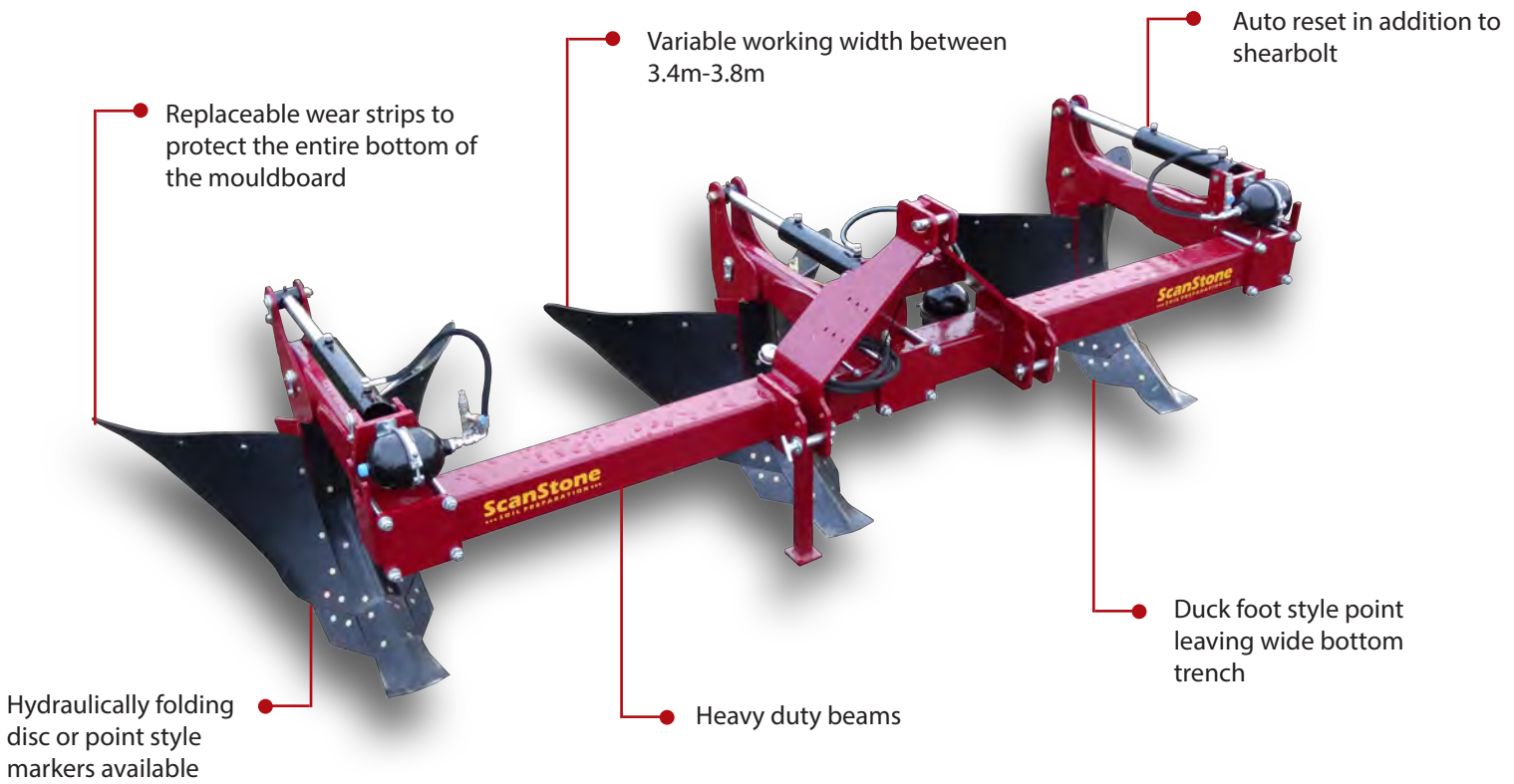

This bed maker is available in **TERRA SPEC**
See page 19 for details

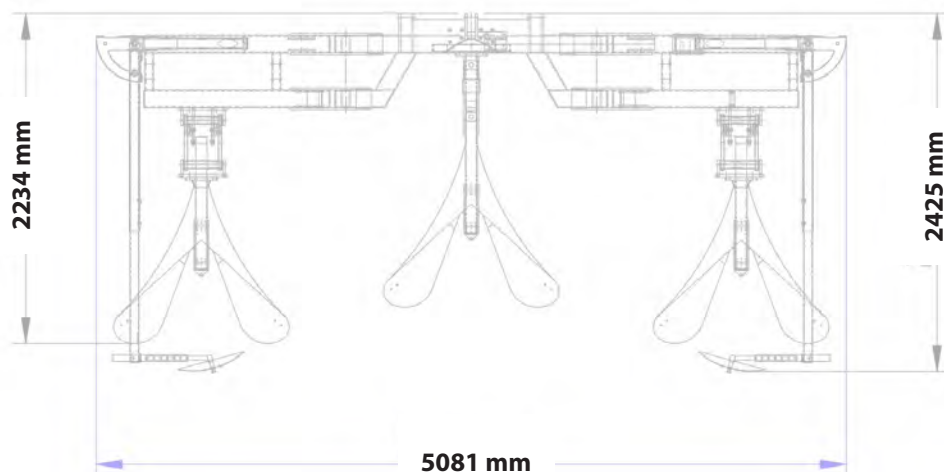

BED MAKING

THE PROCESS

The bed maker is designed to go into pre-cultivated ground, both to create beds for destoning and aerating the soil. It is key for the bed maker to get as much soil as possible out of the trench and into the bed. This gives the destoner the maximum potential.

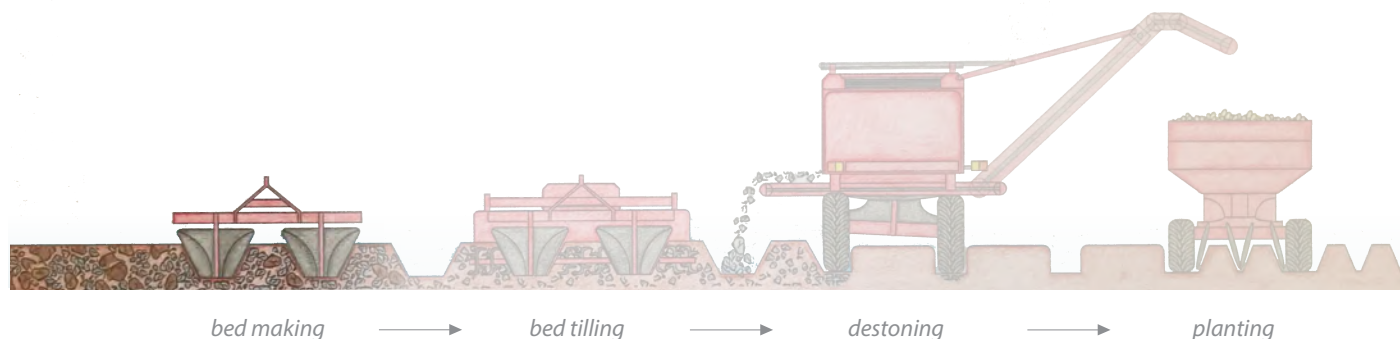

THE CONFIGURATIONS

ScanStone bed makers are available in 2-body, 3-body or 4-body configurations. The 4-body is available in either a heavy-duty or superlight version. Bed makers can be equipped with ScanStone-style mouldboards, or Chateau-style ploughs (which create a steeper, wider bed). The standard ScanStone-style mouldboards are available with a shearbolt, auto-reset or dual action protection, depending on soil conditions and stone content.

The Chateau-style ploughs are available with shearbolt or auto-reset protection. This plough is used in lighter soil conditions where it is achievable to get a castellated bed for an even intake into the destoner. The chateau-style ploughs maintain the classic ScanStone wide bottom trench, which also eliminates to a degree the need to constantly guide the destoner tractor.

AR+ MODELS

The ScanStone AR+ models negate the need for additional shearbolt protection. This auto reset system has a double pivot point allowing the beam to pivot and also the body to pivot as the plough strikes a stone or tree root. There is enough stroke in the hydraulic cylinder for the plough to reset in both instances and enough pressure in the accumulator for the plough to reset back to the preset depth.

STEP 1





STEP 2

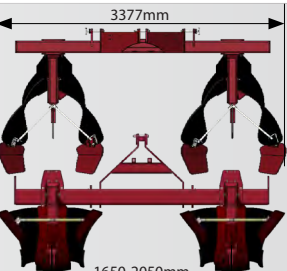

THE CONFIGURATIONS

	2 BODY	3 BODY	4 BODY
SHEARBOLT	<p>2 BODY SHEARBOLT PAGE 5</p> <p>CHATEAU-STYLE available</p> <p>TILLER compatible</p>	<p>3 BODY SHEARBOLT <i>fixed</i> PAGE 11</p> <p>CHATEAU-STYLE available</p> <p>TILLER compatible</p> <p>3 BODY SHEARBOLT <i>folding</i> PAGE 11</p> <p>CHATEAU-STYLE available</p> <p>TILLER compatible</p> <p>TERRA-SPEC available</p>	<p>4 BODY SUPER SHEARBOLT PAGE 21</p> <p>TILLER compatible</p>
AUTO RESET	<p>2 BODY AUTO RESET PAGE 7</p> <p>CHATEAU-STYLE available</p> <p>TILLER compatible</p>	<p>3 BODY AUTO RESET <i>fixed</i> PAGE 13</p> <p>CHATEAU-STYLE available</p> <p>TILLER compatible</p> <p>3 BODY AUTO RESET <i>folding</i> PAGE 15</p> <p>CHATEAU-STYLE available</p> <p>TILLER compatible</p> <p>TERRA-SPEC available</p>	<p>4 BODY SUPER AUTO RESET PAGE 21</p> <p>TILLER compatible</p>
AR +	<p>2 BODY AR+ PAGE 9</p> <p>CHATEAU-STYLE available</p>	<p>3 BODY AR+ <i>folding</i> PAGE 17</p> <p>CHATEAU-STYLE available</p> <p>TERRA-SPEC available</p>	<p>4 BODY HD AR+ PAGE 23</p> <p>CHATEAU-STYLE available</p>

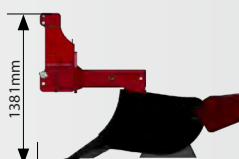
2 BODY SB		 <p>80 hp 400 kg</p>  <p>1381mm 1480mm</p>	 <p>3377mm 1650-2050mm</p>	<p>UN-3842 SB 2 Body Shearbolt</p> <p>2</p>
2 BODY AR		 <p>80 hp 450 kg</p>  <p>1381mm 1680mm</p>	 <p>3377mm 1650-2050mm</p>	<p>UN-3842 AR 2 Body Auto Reset</p> <p>2</p>
2 BODY AR+		 <p>90 hp 560 kg</p>  <p>1432mm 1814mm</p>	 <p>3377mm 1650-2050mm</p>	<p>UN-3842 AR+ 2 Body Non Stop</p> <p>2</p>
3 BODY FX SB		 <p>80 hp 750 kg</p>  <p>1381mm 1480mm</p>	 <p>5081mm 1650-2050mm 1650-2050mm</p>	<p>UN-3844 FX SB 3 Body Shearbolt Fixed Frame</p> <p>3FX</p>
3 BODY FX AR		 <p>80 hp 800 kg</p>  <p>1381mm 1680mm</p>	 <p>5081mm 1650-2050mm 1650-2050mm</p>	<p>UN-3844 FX AR 3 Body Auto Reset Fixed Frame</p> <p>3FX</p>
3 BODY FX AR+		 <p>110 hp 950 kg</p>  <p>1432mm 1814mm</p>	 <p>5081mm 1650-2050mm 1650-2050mm</p>	<p>UN-3844 FX AR+ 3 Body Non Stop Fixed Frame</p> <p>3FX</p>
3 BODY FD SB		 <p>110 hp 1050 kg</p> <p>Transport Width 3.08m Transport Height 2.28m</p>  <p>1381mm 1680mm</p>	 <p>5081mm 1650-2050mm 1650-2050mm</p>	<p>UN-3844 FD SB 3 Body Shearbolt Folding Frame</p> <p>3FD</p>

3 BODY FD AR



150 hp 1300 kg

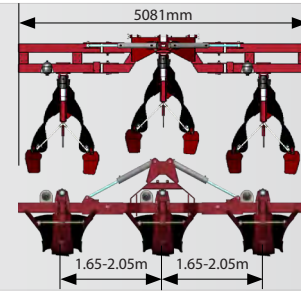
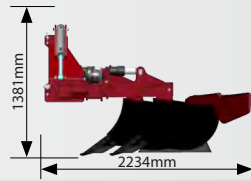

UN-3844 FD AR
3 Body
Auto Reset
Folding Frame

3FD

3 BODY FD AR+



170 hp 1350 kg

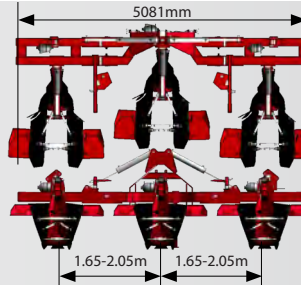
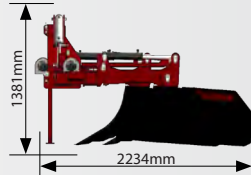

UN-3844 FD AR+
3 Body
Non Stop
Folding Frame

3FD

3 BODY TERRA



180 hp 1500 kg

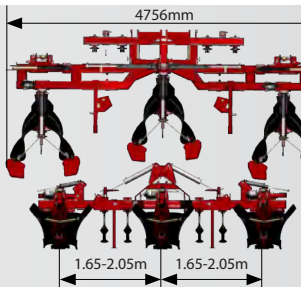
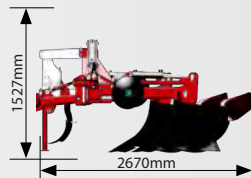

UN-3844 T
3 Body Folding
Non Stop
Heavy Duty Tines

3FD

4 BODY WF SB



160 hp 1400 kg

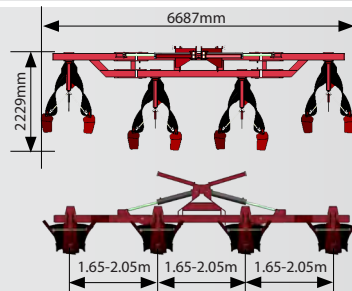
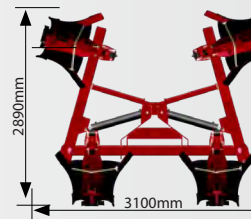

UN-3845 WF SB
4 Body
Shearbolt
Wing-Folding

4WF

4 BODY WF AR



180 hp 1500 kg

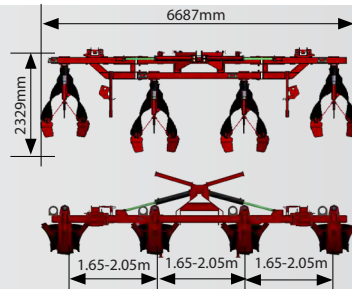
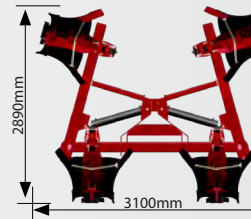

UN-3845 WF AR
4 Body
Auto Reset
Wing-Folding

4WF

4 BODY WF AR+



200 hp 1700 kg

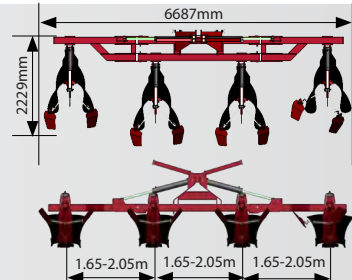
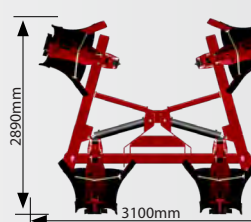

UN-3845 WF AR+
4 Body
Non Stop
Wing-Folding

4WF

4 BODY CF AR+



250 hp 2800 kg

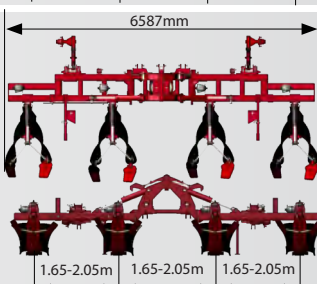
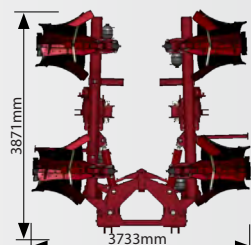

UN-3845 CF
4 Body
Non Stop
Centre-Folding

4CF

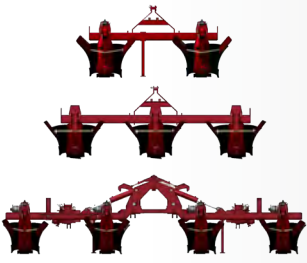

NUMBER OF PLOUGHS

The ScanStone bed former range consists of 2 plough, 3 plough and 4 plough models. The ploughs are adjustable from 1.65-2.05m. The number of ploughs depends on the amount of horsepower available, and the area desired to achieve in one pass.

- **UN-3842** 2 Ploughs
- **UN-3844** 3 Ploughs
- **UN-3845** 4 Ploughs

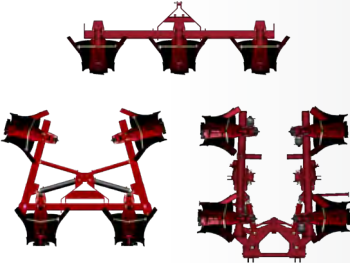

FRAME TYPE

ScanStone bed formers are available with fixed or folding frames.

- **FX** Fixed
- **FD** Folding
- **WF** Wing-Folding
- **CF** Centre-Folding



PLOUGH PROTECTION

Depending on soil conditions and stone content, the ScanStone bed formers can be equipped with shearbolt, auto reset or auto reset plus (non-stop) protection systems. The auto reset version uses hydraulic rams when large stones are encountered, but additionally has a shearbolt system which protects the body when immovable objects are hit.

- **SB** Shearbolt
- **AR** Auto Reset
- **AR+** Auto Reset Plus (Non-Stop)

2 BODY

- **UN-3842 SB** 2 Body Shearbolt
- **UN-3842 AR** 2 Body Auto Reset
- **UN-3842 AR+** 2 Body AR+ (Non-Stop)



3 BODY Fixed

- **UN-3844 FX SB** 3 Body Fixed Shearbolt
- **UN-3844 FX AR** 3 Body Fixed Auto Reset
- **UN-3844 FX AR+** 3 Body Fixed AR+ (Non-Stop)



3 BODY Folding

- **UN-3844 FD SB** 3 Body Folding Shearbolt
- **UN-3844 FD AR** 3 Body Folding Auto Reset
- **UN-3844 FD AR+** 3 Body Folding AR+ (Non-Stop)
- **UN-3844 TERRA** 3 Body Folding AR+ Terra



4 BODY Wing-Folding

- **UN-3845 WF SB** 4 Body Wing-Folding Shearbolt
- **UN-3845 WF AR** 4 Body Wing-Folding Auto Reset
- **UN-3845 WF AR+** 4 Body Wing-Folding AR+ (Non-Stop)



4 BODY Centre-Folding

- **UN-3845 CF AR+** 4 Body Centre-Folding AR+ (Non-Stop)



TRACK WIDTH SETTING

Distance between centre to centre of plough.

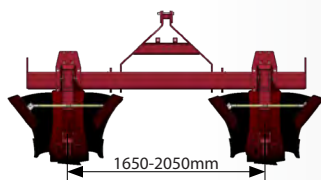

- **SET-001** 1.50 m
- **SET-002** 1.60 m
- **SET-003** 1.65 m
- **SET-004** 1.70 m
- **SET-005** 1.80 m *Default*
- **SET-006** 1.85 m
- **SET-007** 2.00 m

Standard

2 | 3 | 3T | 4WF | 4CF

CLASSIC STYLE PLOUGHS

Leave a wide bottom trench for the stones and clods to lie in. Leaves a bed that is quicker to dry.

- **KIT-1100**

Standard

2 | 3 | 3T | 4WF | 4CF

CHATEAU STYLE PLOUGHSDifferent shape of body to leave a steeper trench. See **page 24** for details.

- **KIT-1109** SB/AR (Per plough)
- **KIT-1116** AR+ (Per plough)

Option

2 | 3 | 3T | 4WF | 4CF

DISC-STYLE HYDRAULIC MARKER KIT

Disc-style markers leave an accurate scribe in the soil giving the operator a useful guide on his return journey up the field, when not using GPS.

- **KIT-1084** 2 & 4 Body (Pair)
- **KIT-1080** 3 Body (Pair)

Option

2 | 3 | 3T | 4WF | 4CF

POINT-STYLE HYDRAULIC MARKER KIT

Point-style markers are a less expensive option and virtually maintenance-free. Mainly used to assist the operator should be GPS fail.

- **KIT-1081** (Pair)

Option

2 | 3 | 3T | 4WF | 4CF

HYDRAULICALLY EXTENDABLE MARKER KIT

In conditions where GPS coverage may be limited, the hydraulic extendable markers provide centre marking while operating the ScanStone 4 body bed former with 4 ploughs down. Comes with a choice of disc or point.

- **BOM-0337** (Pair)

Option

2 | 3 | 3T | 4WF | 4CF

STABILISER FINS

Stabiliser fins act as as rudder to the plough to improve stability during work. Fins are not compatible with Chateau ploughs.

- **KIT-1102** (Each)

Option

2 | 3 | 3T | 4WF | 4CF



MANUAL DEPTH WHEEL KIT

To act as a depth guide and keep the ploughs from digging in too deep.

- **KIT-1127** 15"
- **KIT-1122** 18"

Option / Standard				
2	3	3T	4WF	4CF
2	3	3T	4WF	4CF



HYDRAULIC DEPTH WHEEL KIT

To act as a depth guide and keep the ploughs from digging in too deep.

- **BOM-1128** 15"
- **BOM-1123** 18" (in lieu)

Option				
2	3	3T	4WF	4CF
2	3	3T	4WF	4CF



PARALLEL LINKAGE KIT

For keeping the ploughs level when working in half depths.

- **BOM-0315**

Option				
2	3	3T	4WF	4CF

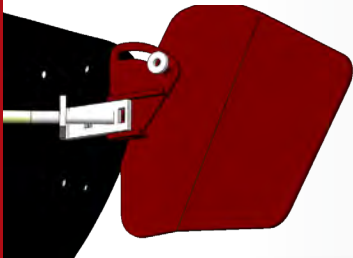

LARGE TAIL PIECES

Attached at the top of the mouldboard, the tail pieces keep the side wall of the bed in position in deeper and heavier conditions. Not compatible with Chateau ploughs.

- **BOM-0371** Pair

Option				
2	3	3T	4WF	4CF



EASY DUTY CULTIVATOR TINE

To break up the soil before the ploughs engage.

- **KIT-1114** Each

Option				
2	3	3T	4WF	4CF



HEAVY DUTY CULTIVATOR TINE

To break up the soil before the ploughs engage.

- **KIT-1130** Each

Option				
2	3	3T	4WF	4CF

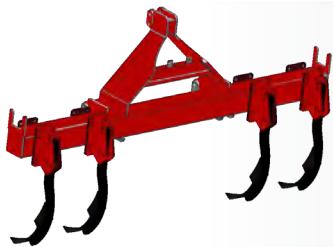

CULTIVATOR TINE TOOLBAR

This removable toolbar is made up of four spring-loaded tines, which are situated forward of the ridging ploughs, allowing the soil to flow through the system more effectively.

- **BOM-0318** Each

Option / Standard				
2	3	3T	4WF	4CF



TOOL BOX

Useful for storing tools, spare parts and other maintenance essentials.

- **BOM-0319**

Option

2	3	3T	4WF	4CF
---	---	----	-----	-----



UNIQUE PARTS LIST

Each individual bed former comes as standard with a unique parts manual which features the exact specifications and equipment which is mounted on the machine before it leaves the factory. Customers are able to quote their serial number to their parts provider, to ensure that the correct parts are ordered. Not only does this speed up the ordering process, but avoids mistakes.

Standard

2	3	3T	4WF	4CF
---	---	----	-----	-----



USER MANUAL / MACHINE STICKERS

The country of use kit consists of a hard-copy of the user manual and machine stickers in the country's spoken language.

- *English (Standard)*
- *French*

Standard

2	3	3T	4WF	4CF
---	---	----	-----	-----



GALLERY 2

BED MAKERS



PARTS

SERVICE

DEALERS

TESTIMONIALS

GALLERY

**3 BODY
BED MAKER**